

Article number: 20343550M12KSE

Description: E+G levelling foot  
GN 343.5-50-M12-KSE

## Measures

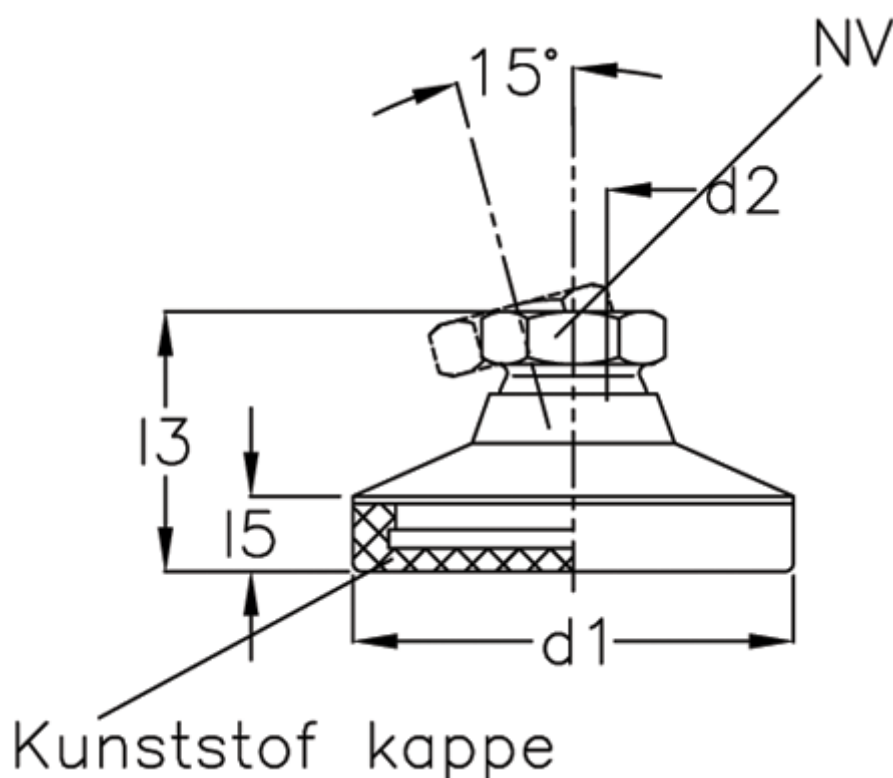

d1	= 50
d2	= 12
l3	= 29.5
l5	= 8.5
NV	= 17
Static load (N)	= 16
t min	= 11.5